



COLOUR TELEVISION

HV-29ML25

HV-29VL25

HV-29VL15

Contents

Knowing your TV's feature	2
Remote control buttons and basic functions .	3
TV buttons and functions	5
Setting up your TV	6
Basic setting for picture	8
Advanced setting for picture	9
Original Feature for picture	10
Basic setting for sound	11
Advanced setting for sound	12
DVD Function	13
Customized setting	14
TV channel presetting	17
Additional preparation	19
Troubleshooting	20
Specifications	22



INSTRUCTIONS

Thank you for buying this JVC colour television.

To make sure you understand how to use your new TV, please read this manual thoroughly before you begin.

Safety Instructions

WARNING: TO PREVENT FIRE OR SHOCK HAZARD, DO NOT EXPOSE THIS APPLIANCE TO RAIN OR MOISTURE.

CAUTION: TO ENSURE PERSONAL SAFETY, OBSERVE THE FOLLOWING RULES REGARDING THE USE OF THIS TV.

- 1 Operate only from the power source indicated on the rear of the TV.
- 2 Avoid damaging the power cord and mains plug. When unplugging the TV, grasp the mains plug. Do not pull on the power cord.
- 3 Never block or cover the cabinet ventilation openings. Never install the TV where good ventilation is unattainable. When installing this TV, leave spaces for ventilation around the TV more than the minimum distances as shown in the diagram.
- 4 Do not allow objects or liquid into the cabinet openings.
- 5 In the event of a fault, unplug the unit and call a JVC service technician. Do not attempt to repair it yourself or remove the rear cover.
- 6 The surface of the TV screen is easily damaged. Be very careful with it when handling the TV. Should the TV screen become soiled, wipe it with a soft dry cloth. Never rub it forcefully. Never use any cleaner or detergent on it.
- 7 If you are not going to use this TV for a long period of time, be sure to disconnect the AC plug from the AC socket.
- 8 The apparatus shall not be exposed to dripping or splashing and that no objects filled with liquids, such as vases, shall be placed on the apparatus.

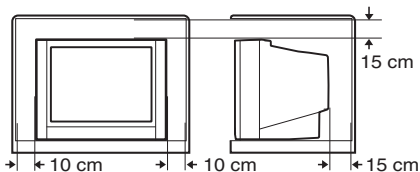

WARNING: <HV-29M Series>

YOU CAN DETACH THE PROTECT SHEET ON THE TOP AND BOTTOM OF FRONT FRAME IF YOU NEEDED. THE FRONT BUTTON DOOR OF THE TV SHOULD BE PULLED OUT FROM ITS BOTTOM. DO NOT PRESS THE UPPER PART, OR YOUR FINGER MAY BE PINCHED.

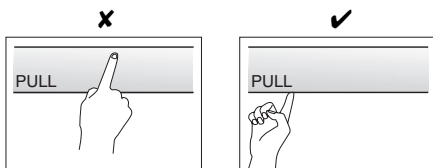

Knowing your TV's feature

Main feature

Function	Description
DVD MENU	Just connect your DVD IN, your new TV can check the DVD signal and will display the picture automatically. You can also tune the Picture mode and the sound mode as you like while watching your DVD.

Remote control buttons and basic functions

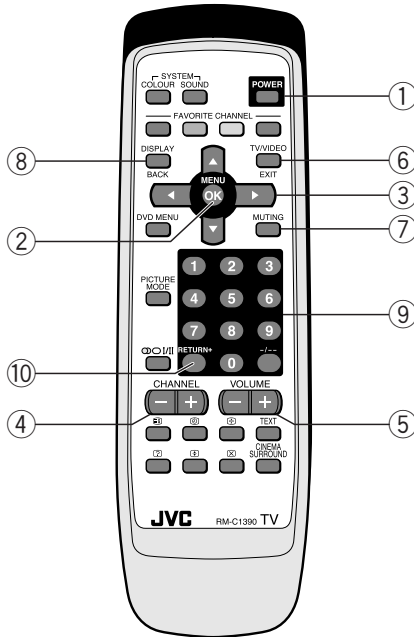

RM-C1390

No. Press	To
① POWER	Turn on or off the TV from standby mode.
② MENU/OK	Display menu and confirm selected function.
③ ▲/▼/◀/▶	Select and adjust menu function.
④ CHANNEL -/+	Select the desired channel number.
⑤ VOLUME -/+	Adjust the volume level.
⑥ TV/VIDEO EXIT	Select TV or VIDEO terminal input. On the other hand, you can use this button to EXIT from the menu.
⑦ MUTING	Turn off the volume. Press this button again to resume the volume.
⑧ DISPLAY /BACK	Display the programme number or video terminal number and PR list (channel list) on the screen. You can select the channel using the PR list. 1 Press the DISPLAY/BACK button once to display the PR list. 2 Press ▲/▼/◀/▶ button to choose a channel, then press the MENU/OK button. You can confirm the favorite channels in the PR list. The channels set to favorite channels are indicated with coloured mark. On the other hand, you can use this button to return to the previous menu.
⑨ 0~9, -/--	Select the programme number. For two digits programme number, press -/--, then press the number button.
⑩ RETURN+	a) Return to the frequently view channel with one touch. 1 Choose the channel you want to register. 2 Press and hold RETURN+ button until "RETURN PLUS PROGRAMMED!" appears. To cancel, press and hold RETURN+ button until "RETURN PLUS CANCELED!" appears. b) Return to the previously viewed channel, if you have not set or have cancelled the Return channel as above.

Remote control buttons and basic functions (continued)

How to operate menus and menu locations

TO	Operation	Note
Display the MENU.	Press the MENU/OK button ②.	To exit the MENU, press the DISPLAY/BACK button ⑧ or choose EXIT menu or TV/VIDEO/EXIT button ⑥.
Display the top.	Press ◀▶ buttons ③ to choose a menu title. Then press MENU/OK button ②.	Press ▼ button ③ to display next page for more functions.
Display the 2nd menu.	Press ▲▼ buttons ③ to choose a menu title. Then press MENU/OK button ②.	
Display the 3rd menu.	Press ▲▼ buttons ③ to choose a menu title. Then press MENU/OK button ②.	
Return to the previous menu.	Press the DISPLAY/BACK button* ⑧.	-
Choose the setting of a function.	Press ▲▼ buttons ③ to choose a function. Then press the ◀▶ buttons ③ to change the setting.	Press the MENU/OK button ② to exit from the menu.
Adjust the effect level of a function.	Press ▲▼ buttons ③ to choose a function. Then press the ◀▶ buttons ③ to adjust the effect level.	
Display the sub menu of a function.	Press ▲▼ buttons ③ to choose a function. Then press MENU/OK button ② to display the sub menu.	-

The following chart shows locations of functions in menus. In this manual, location of a function is described as follows:

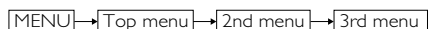
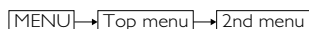

Note: Some functions have the 4th menus as the sub-menus.

	Top menu	2nd menu	Location	3rd menu	Location	
MENU	PICTURE	PICTURE MODE	P.8			
		PICTURE SETTING	CONTRAST	P.8		
			BRIGHT	P.8		
			SHARP	P.8		
			COLOUR	P.8		
			TINT	P.8		
		WHITE BALANCE	P.8			
		DIGITAL VNR	P.14			
		SOUND	STEREO / I-II	P.11		
			BASS	P.11		
	TREBLE		P.11			
	BALANCE		P.11			
	AI VOLUME		P.12			
	CINEMA SURROUND		P.12			
	FEATURES	DVD MENU	DVD MENU	P.13	AUTO SIGNAL DETECT	P.13
					DVD PICTURE MODE	P.13
					WHITE BALANCE	P.13
					SOUND MODE	P.13
					CINEMA SURROUND	P.13
		SLEEP TIMER	P.14			
		CHANNEL GUARD	P.14			
		CHILD LOCK	P.15			
		ZOOM	P.9			
FAVORITE SETTING		P.15				
INSTALL	SETUP TOUR	P.16				
	AUTO PROGRAM	P.17				
	EDIT/MANUAL	P.17				
	COLOUR SYSTEM	P.8				
	LANGUAGE	P.14				
	TELETEXT LANGUAGE	P.10				
	APPEARANCE	P.16				
	VIDEO - 3 SETTING	P.16				
	BLUE BACK	P.9				
AUTO SHUTOFF	P.16					
PICTURE TILT	P.9					

TV buttons and functions

The illustrations shown below is for HV-29ML25 and HV-29VL25 only, which are used for explanation purpose. Your TV may not look exactly the same as illustrated.

Front of the TV

HV-29ML25

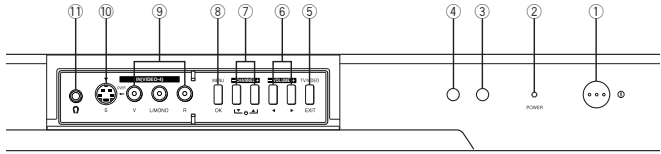

HV-29VL25

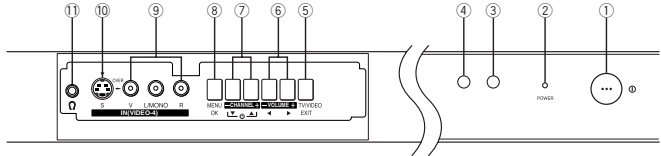

Rear of the TV

HV-29ML25

HV-29VL25

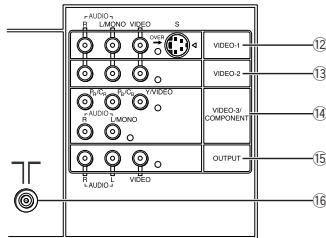

No.	Button/terminal	Description
①	① (main power)	Press to turn on or turn off the TV's main power.
②	Power lamp	Indicate the TV is being turned on or off. No colour : TV's main power is being turned off. Red : TV's main power is being turned on.
③	Not Application	
④	Remote control sensor	
⑤	TV/VIDEO	Press to select TV or video mode.
⑥	VOLUME +/-	Press to adjust the volume level.
⑦	CHANNEL +/-	Press to select the desired channel.
⑧	MENU	Press to display the menu.
⑨	IN (VIDEO-4)	Video and audio input jacks for VIDEO-4 mode.
⑩	S-VIDEO	S-VIDEO signal input for VIDEO-4 mode.
⑪	Ω	Headphone jack.
⑫	VIDEO-1	Video or S-VIDEO, and audio input jacks for VIDEO-1 mode.
⑬	VIDEO-2	Video and audio input jacks for VIDEO-2 mode.
⑭	VIDEO-3/COMPONENT	Video or COMPONENT, and audio input jacks for VIDEO-3 mode.
⑮	OUTPUT	Video and audio output jacks.
⑯	ㄗ	Aerial socket.

How to operate the menus with the TV button

TV button	Work as same as the button on the remote control unit	Note
MENU	MENU/OK button	To display main menu and exit menu after finish setting.
CHANNEL +/-	▼/▲ button	To select menu function.
VOLUME +/-	◀/▶ button	To adjust the desired function.

Setting up your TV

CAUTION

- Turn off the equipment including the TV before connecting.

1 Connecting the aerial cable.

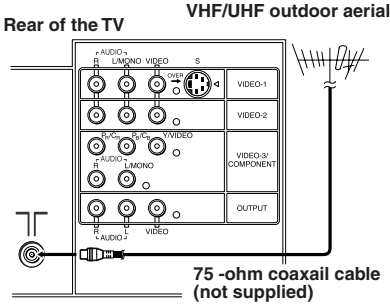

If you connect a VCR, connect the aerial output jack of your VCR and the aerial jack on the TV with the aerial cable. Then connect the output jacks of your VCR and the VIDEO-1 input jacks of the TV with the video cable and audio cables. For details, see the manual of your VCR.

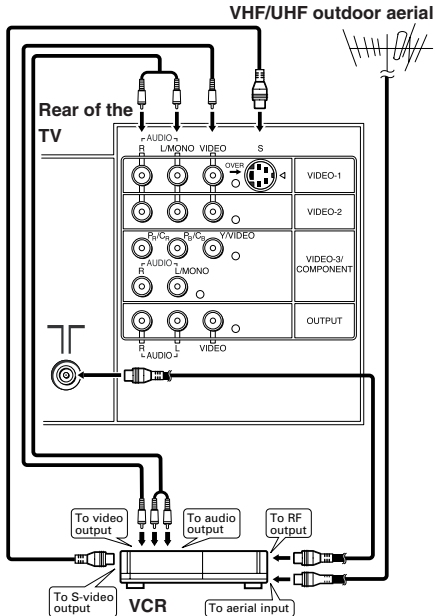

The illustration shown is just a sample. It may not be same as your TV.

2 Connecting the compatible main plug to the AC outlet.

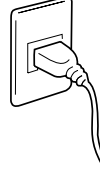

3 Inserting batteries into the remote control.

Insert two batteries by following the \oplus and \ominus polarities and inserting the \ominus end first.

CAUTION:

Follow the cautions printed on the batteries.

Notes:

- Use AA/R6/UM-3 dry cell batteries.
- If the remote control does not work properly, fit new batteries. The supplied batteries are for testing, not regular use.

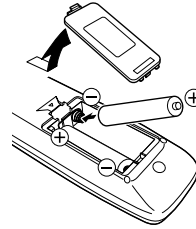

4 Turn on the TV by pressing the main power button.

JVC logo appears on the screen.



JVC logo will appear on the screen again at the phase of "SETUP TOUR RESTART?" function. Then the initial setting can be performed according to page 7.

Setting up your TV (continued)

5 Making the initial settings

Set up your TV by pressing MENU/OK button or any keys, then operate the TV by following the steps as below:

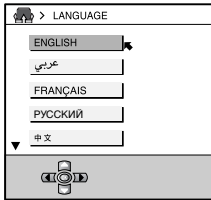

- Press ▲/▼ button to select your desired language.

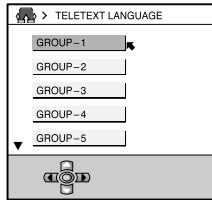

- Press ▲/▼ button to select your desired Teletext language groups. For details, see page 10.

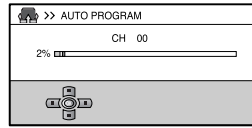

- TV will start searching for the channels.

To stop AUTO PROGRAM, press MENU/OK button.

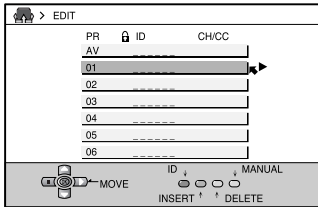

- To complete the initial setting, press the MENU/OK button. To edit the channel list, see page 18.

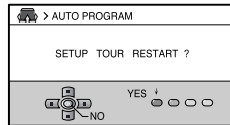

- After that, when turn on the TV at the next time. "SETUP TOUR RESTART?" will be displayed. Press the MENU/OK button to cancel the SETUP TOUR RESTART function. If you want to make initial settings again when the next time you turn on the TV, press the Red button to activate the SETUP TOUR RESTART function.

Basic setting for picture

COLOUR SYSTEM

You can select the appropriate colour system when the picture is not clear or no colour appears.

Press the COLOUR SYSTEM button to select a setting.

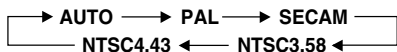

To operate this function with a menu:

* [MENU] → [INSTALL] → [COLOUR SYSTEM]

For the colour system in each country or region, see the table below:

Area	Country or Region	System
Asia, Middle East	Bahrain, Kuwait, Oman, Qatar, United Arab Emirates, Yemen, etc.	PAL
	Indonesia, Malaysia, Singapore, Thailand, India, etc.	PAL
	China, Vietnam, etc.	PAL
	Hong Kong, etc.	PAL
	Islamic Republic of Iran, Lebanon, Saudi Arabia, etc.	SECAM
Europe	Philippines, Taiwan, Myanmar, etc.	NTSC
	Russia, etc.	SECAM
	Czech Republic, Poland, etc.	PAL
	Germany, Holland, Belgium, etc.	PAL
Oceania	UK, etc.	PAL
	Australia, New Zealand, etc.	PAL
Africa	Republic of South Africa, etc.	PAL
	Nigeria, etc.	PAL
	Egypt, Morocco, etc.	SECAM

PICTURE MODE

You can choose the desired picture setting with one-touch.

Press the PICTURE MODE button to select a setting.

SOFT	Softens contrast and sharpness.
BRIGHT	Heightens contrast and sharpness.
STANDARD	Standard picture setting.
USER	You can change this picture setting as you like. Select USER and adjust following items in the PICTURE SETTING menu. (CONTRAST, BRIGHT, SHARP, COLOUR, TINT*)

*TINT can only be adjusted in NTSC system.
When you select to VIDEO-3 mode. You can not adjust SHARP.

To operate this function with a menu:

* [MENU] → [PICTURE] → [PICTURE MODE]

To return the USER setting to the default, press the blue button when the PICTURE SETTING menu appears.

PICTURE SETTING

You can adjust the desired picture setting when selecting USER in PICTURE MODE.

1 Select the USER in PICTURE MODE under PICTURE menu.

* [MENU] → [PICTURE] → [PICTURE MODE] → [USER]

2 Select the PICTURE SETTING in PICTURE menu, then adjust the setting.

* [MENU] → [PICTURE] → [PICTURE SETTING]

CONTRAST	◀ : Lower contrast	▶ : Higher contrast
BRIGHT	◀ : Darker	▶ : Brighter
SHARP	◀ : Softer	▶ : Higher
COLOUR	◀ : Lighter	▶ : Deeper
TINT*	◀ : Reddish	▶ : Greenish

*TINT can only be adjusted in NTSC system.

When you select to VIDEO-3 mode. You can not adjust SHARP.

WHITE BALANCE

You can change the white balance of the picture to better match the type of video being viewed. Select the WHITE BALANCE in the PICTURE menu, then choose the desired setting.

* [MENU] → [PICTURE] → [WHITE BALANCE]

MID	Normal white balance.
WARM	Reddish white.
COOL	Bluish white.

When you select to VIDEO-3. You cannot adjust WHITE BALANCE. You can adjust it in DVD Menu.

* About the basic operations of the menu, please see the “How to operate menus and menu locations” on page 4.

Advance setting for picture

BLUE BACK

You can set the TV to automatically change to a blue screen and mute the sound if the signal is weak or absent, or when there is no input from an antenna.

Select the BLUE BACK in the INSTALL menu, then choose ON or OFF.

※ [MENU] → [INSTALL] → [BLUE BACK]

If you wish to continue viewing the poor picture, cancel the BLUE BACK function.

ZOOM

You can change the screen size according to the picture aspect ratio. Choose the optimum one from three ZOOM modes.

- 1 Select the ZOOM in the FEATURES menu, then press the MENU/OK button.

※ [MENU] → [FEATURES] → [ZOOM]

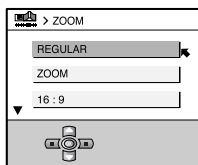

- 2 Press the ▲/▼ buttons to choose a ZOOM mode. Then press the MENU/OK button.

PICTURE TILT

Correcting the Slanting Picture (PICTURE TILT)

You can correct the picture tilt caused by the earth's magnetic force.

- 1 Select the PICTURE TILT in the INSTALL menu, then press MENU/OK button.

※ [MENU] → [INSTALL] → [PICTURE TILT]

The Following display appear.

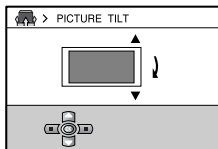

- 2 Press the ▲/▼ buttons until the picture become level. Then press the MENU/OK button.

※ About the basic operations of the menu, please see the “How to operate menus and menu locations” on page 4.

Original features for picture

TELETEXT (Except HV-29VL15 only)

You can watch the Teletext broadcast channel with TEXT function.

1 Press the TEXT button to select the desired mode as follows:

▶ TV mode → TEXT twin mode → TEXT mode

2 Press the CHANNEL +/- buttons, number buttons or colour buttons to select other Teletext pages.

3 Press TEXT or TV/VIDEO button to return to TV mode. You can also operate the teletext using the following buttons:

⏸ (Hold)	Hold a teletext page. The ⏸ (Hold) are displayed at the top left of the screen. To cancel, press ⏸ (Hold) button again.
🔍 (Reveal)	Display the hidden text (e.g. answers to a quiz). To cancel, press 🔍 (Reveal) button again.
🔍 (Size)	Enlarge the teletext display.
📄 (Index)	Return to the index page instantly.
⏹ (Cancel)	Watch TV programme while waiting for a teletext page. When the teletext page is found, a page number appears at the upper left of the screen. Press ⏹ (Cancel) to view the teletext page.
📄 (Sub-page)	Operate the 📄 (Sub-page) function. Sub-page numbers are displayed at the left of the screen. To cancel sub-page function, press 📄 (Sub-page) button again.

TELETEXT LANGUAGE

You can set the Teletext language group that corresponds to the programmes. Select TELETEXT LANGUAGE in the INSTALL menu, then choose the desired language group.

* [MENU] → [INSTALL] → [TELETEXT LANGUAGE]

Group	Languages
GROUP-1	Turkish, Hungarian, English, German, French, Italian, Spanish, Portuguese, Greek, Swedish, Finnish
GROUP-2	Polish, Serbian, Croatian, Slovenian, Czech, Slovak, Rumanian, Hungarian, German, French, Italian, Swedish, Finnish
GROUP-3	Russian, Bulgarian, Lettish, Lithuanian, Estonian, Ukrainian, Czech, Slovak, English, German, Rumanian
GROUP-4	Arabic, Czech, Slovak, Hungarian, English, German, French, Italian, Spanish, Portuguese, Swedish, Finnish
GROUP-5	Farsi, Czech, Slovak, Hungarian, English, German, French, Italian, Spanish, Portuguese, Swedish, Finnish

Depending on the broadcast, the language set may not display properly. For details, see in page 8.

* About the basic operations of the menu, please see the “How to operate menus and menu locations” on page 4.

Basic setting for sound

SOUND SYSTEM

You can select an appropriate sound system when abnormal sound occurs even when the picture appears normally.

Press the SOUND SYSTEM button to select a setting.

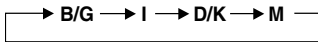

The function is not available in video mode.
For the sound system in each country or region, see the table below:

Area	Country or Region	System
Asia, Middle East	Bahrain, Kuwait, Oman, Qatar, United Arab Emirates, Yemen, etc. Indonesia, Malaysia, Singapore, Thailand, India, etc.	B/G
	China, Vietnam, etc.	D/K
	Hong Kong, etc.	I
	Islamic Republic of Iran, Lebanon, Saudi Arabia, etc.	B/G
	Philippines, Taiwan, Myanmar, etc.	M
Europe	Russia, etc.	D/K
	Czech Republic, Poland, etc.	D/K
	Germany, Holland, Belgium, etc.	B/G
	UK, etc.	I
Oceania	Australia, New Zealand, etc.	B/G
Africa	Republic of South Africa, etc.	I
	Nigeria, etc.	B/G
	Egypt, Morocco, etc.	B/G

STEREO / I•II (O O I/II)

You can enjoy the stereo and bilingual broadcasted programmes. Press the O O I/II button to select the desired mode.

O	Select stereo sound.
O	Select monaral sound.
I	Select bilingual I (sub I).
II	Select bilingual II (sub II).
MONO	Cancel the Multi Sound functions, and the sound becomes monaural.

This Function is not available in video mode.
To operate this function with a menu:



ADJUSTING THE SOUND

You can adjust the sound setting.
Select the BASS, TREBLE and BALANCE in SOUND menu, then adjust the setting.



BASS	◀ : Weaker	▶ : Stronger
TREBLE	◀ : Weaker	▶ : Stronger
BALANCE	◀ : Left speaker level up	▶ : Right speaker level up

* When you select SOUND MODE of DVD menu in VIDEO-3 to DYNAMIC or SOFT, you cannot adjust BASS and TREBLE.

Advanced setting for sound

AI VOLUME

You can adjust the volume of all the channels and video inputs to the same level automatically. Select the AI VOLUME in SOUND menu, then choose ON or OFF.

* [MENU] → [SOUND] → [AI VOLUME]

CINEMA SURROUND

You can enjoy an enhanced sound for wider audience. Press the CINEMA SURROUND button to select a setting.

OFF	Cancel the function.
HIGH	Listen to sound with more wider audience effect.
LOW	Listen to sound with less wider audience effect.
MONO	Listen to mono sound with stereo effect.

To operate this function with menu:

* [MENU] → [SOUND] → [CINEMA SURROUND]

If slight volume distortion occurs when you select HIGH mode, change the setting to LOW mode. The CINEMA SURROUND effect will be less noticeable.

DVD FUNCTION

AUTO SIGNAL DETECT

When the DVD input signal is detected. The input mode will be changed to VIDEO-3 automatically.

For The DVD player, press the “POWER ON” button of the machine so that the signal can be detected.

For the VTR, press the “POWER ON” button of the machine, and then press the “PLAY” button, so that the signal can be detected and display DVD menu.

Select the AUTO SIGNAL DETECT in DVD MENU under FEATURES menu then choose ON or OFF (Factory setting is ON).

* [MENU] → [FEATURES] → [DVD MENU]
→ [AUTO SIGNAL DETECT]

DVD PICTURE MODE

You can enhance the picture quality of the DVD. Select the DVD PICTURE MODE in DVD MENU under FEATURES menu, then choose the desired setting.

* [MENU] → [FEATURES] → [DVD MENU]
→ [DVD PICTURE MODE]

OFF	Cancel the function.
CLEAR-1	Select when the disc is with lots of noise (To soften the picture).
CLEAR-2	Select when the disc is with less noise (To sharpen the picture).

WHITE BALANCE

You can change the white balance of the DVD picture. Select the WHITE BALANCE in DVD MENU under FEATURES menu, then choose the desired setting.

* [MENU] → [FEATURES] → [DVD MENU]
→ [WHITE BALANCE]

For details, see “WHITE BALANCE” on page 8

SOUND MODE

You can choose the desired sound setting for the DVD. Select the SOUND MODE in DVD MENU under FEATURES menu, then choose the desired setting.

* [MENU] → [FEATURES] → [DVD MENU]
→ [SOUND MODE]

DYNAMIC	Adjust bass and high pitch
SOFT	Soften the sound
USER	You can adjust bass and treble Sound menu as you like. You can use blue button for reset bass / treble to center.

* When you use Sound mode is DYNAMIC or SOFT the Bass and Treble in sound menu cannot operate.

CINEMA SURROUND

You can enjoy an enhanced sound for the DVD. Select the CINEMA SURROUND in DVD MENU under FEATURES menu, then choose the desired setting.

* [MENU] → [FEATURES] → [DVD MENU]
→ [CINEMA SURROUND]

For details, see “CINEMA SURROUND” on page 12

* When you use VIDEO-3 to display the DVD signal or Video signal then WHITE BALANCE, DIGITAL VNR function in PICTURE menu/ BASS, TREBLE, CINEMA SURROUND function in SOUND menu/ SHARP function in PICTURE SETTING menu can't operate.

* About the basic operations of the menu, please see the “How to operate menus and menu locations” on page 4.

Customized setting

DIGITAL VNR

You can reduce the picture noise. Select the DIGITAL VNR in the PICTURE menu, then choose a setting of DIGITAL VNR function.

* [MENU] → [PICTURE] → [DIGITAL VNR]

OFF	DIGITAL VNR is turned off.
MIN	Effect of DIGITAL VNR becomes minimum level.
AUTO	Effect of DIGITAL VNR is automatically controlled.
MAX	Effect of DIGITAL VNR becomes maximum level.

If you select MAX, the picture becomes softer even if the original picture is sharp.
When you select to VIDEO-3 mode. You can not adjust DIGITAL VNR.

SLEEP TIMER

You can set the TV to turn off automatically to standby mode after a set time.

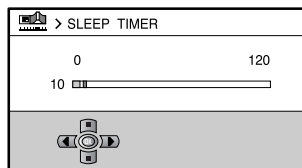

You can set the period of time to a maximum of 120 minutes in 10 minutes step. You must press "OK" button for setting timer.

To operate this function with a menu:

* [MENU] → [FEATURES] → [SLEEP TIMER]

When the elapsed of time left one minute, "GOOD NIGHT!" appears on the screen. You can display the SLEEP TIMER menu again to confirm or change the remaining time.

LANGUAGE

You can choose your desired on screen display language. Select the LANGUAGE in the INSTALL menu, then choose a language.

* [MENU] → [INSTALL] → [LANGUAGE]

CHANNEL GUARD

When there is a TV channel you do not want your children to watch, you can lock out the channel. Even when a child chooses a programme number for a locked out channel the screen will change to blue and display  so the channel cannot be viewed.

To set this function:

- 1 Choose CHANNEL GUARD, then press the number 0 (AV) button.

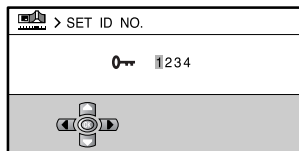

- 2 Set the ID number you want.

To choose a number:



Press the ▲/▼ buttons.

To move a cursor:

Press the ◀/▶ buttons.

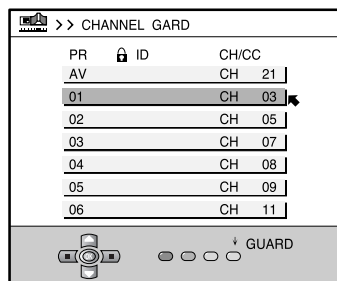
- 3 Press the MENU/OK button.



- 4 Press the ▲/▼ buttons to choose a TV channel.
 - The TV shows the TV programme which the chosen TV channel is now.
- 5 Press the blue button to set this function to the TV channel.
 -  (CHANNEL GUARD) appears and the TV channel is locked. To cancel this function: Press the blue button again.
 -  (CHANNEL GUARD) disappears and the lock is released.
- 6 Press the MENU/OK button to complete the setting. The menu disappears. Press the blue button again.

* About the basic operations of the menu, please see the "How to operate menus and menu locations" on page 4.

Customized setting (continued)

To view a locked TV channel:

- 1 Choose a programme number in which a TV channel locked with the number buttons or PR_LIST. The screen changes to blue and the  (CHANNEL GUARD) appears.

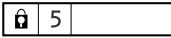

- You cannot choose a locked TV channel with the /∞ buttons.

- 2 Press the DISPLAY button to display "ID NO." (ID number input screen).

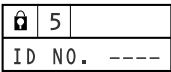

- 3 Press the number buttons to enter the ID number. The lock is temporarily released so you can view the TV channel.

If you have forgotten the ID number: Perform step 1 of "To set this function:" on page 14. After confirming the ID number, press the DISPLAY/BACK button or the TV/VIDEO button to exit the menu.

- When you would like to cancel the CHANNEL GUARD function, you must perform the operation "To set this function" again.

CHILD LOCK

You can disable the front control buttons of the TV. Select the CHILD LOCK in the FEATURES menu, then choose ON or OFF.

- *  →  → 

EXPLANATION FAVORITE SETTING FUNCTION IN FEATURES MENU.

First, there is no register channel in Favorite channel (Red, Green, Yellow, Blue). When you press the colours buttons (Red, Green, Yellow, Blue), the word "NO MEMORY" will appear.

If you press the colours buttons (Red, Green, Yellow, Blue), and remain for a while, the word "FAVORITE CHANNEL ■ PROGRAMMED!" will appear. This means that you register that channel to be your favorite channel. If you want to change your favorite channel in that colour, you must return to the Function FAVORITE SETTING for delete the own one first.

Select the FAVORITE SETTING in the FEATURES menu, then choose desired setting.

- *  →  → 

The following display appear.

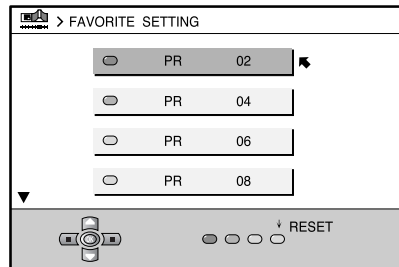

- * About the basic operations of the menu, please see the "How to operate menus and menu locations" on page 4.

Customized setting (continued)

APPEARANCE

You can change format of Menu display when selecting Type of APPEARANCE in the INSTALL menu, then choose the desired setting.

* [MENU] → [INSTALL] → [APPEARANCE]

TYPE A : Solid Form

TYPE B : Light Form

TYPE C : Light background Form/Solid bar

VIDEO-3 SETTING

You can set the VIDEO-3 SETTING according to the video signal output from the external devices connected to the VIDEO-3 terminal. Select the VIDEO-3 SETTING in INSTALL menu, then choose a setting.

* [MENU] → [INSTALL] → [VIDEO-3 SETTING]

VIDEO	If a normal video signal (composite video signal) is input.
COMPONENT	If a component video signal (Y/C _B /C _R) is input.

You must choose a setting follow as signal that you input to VIDEO-3. (If you input the DVD signal to VIDEO-3, you must choose VIDEO-3 SETTING to COMPONENT.)

For connecting methods, see “Additional Preparation” on page 19.

AUTO SHUTOFF

You can set the TV to turn off automatically when no signal is received for about 15 minutes or longer after the end of a broadcast. Select AUTO SHUT OFF in INSTALL menu, then choose ON or OFF.

* [MENU] → [INSTALL] → [AUTO SHUTOFF]

The AUTO SHUTOFF function does not turn off the TV's main power. The AUTO SHUTOFF function is not available in video mode.

SETUP TOUR

You can use SETUP TOUR function for making the initial settings. When you select SETUP TOUR the LANGUAGE menu ,TEXT LANGUAGE menu , AUTO PROGRAM menu , EDIT menu will be displayed follow as page 7. But “SETUP TOUR RESTART?” will not be displayed.

Select the SETUP TOUR in INSTALL menu

* [MENU] → [INSTALL] → [SETUP TOUR]

TV channel presetting

To register the TV channels automatically (AUTO PROGRAM)

You can register the TV channels into the TV's channel list automatically.

- 1 Display the INSTALL menu.

* [MENU] → [INSTALL]

- 2 Choose AUTO PROGRAM, then press the MENU/OK button.

AUTO PROGRAM function starts, and the channels received are registered in the channel list (PR list) automatically.

- 3 The EDIT menu appears.

To edit the channel list	Proceed to the Step 3 of "To edit the channel list (PR list)" on this page.
--------------------------	-----------------------------------------------------------------------------

If a channel is not registered	Proceed to the Step 3 of "To register the channel manually" on this page.
--------------------------------	---------------------------------------------------------------------------

To exit the menu	Press the MENU/OK button.
------------------	---------------------------

For details of "SETUP TOUR", see page 16.

To register the TV channels manually (MANUAL in the EDIT menu)

You can register the TV channels into the TV's channel list manually.

- 1 Display the INSTALL menu.

* [MENU] → [INSTALL]

- 2 Choose EDIT/ MANUAL, then press the MENU/OK button. EDIT menu appears.

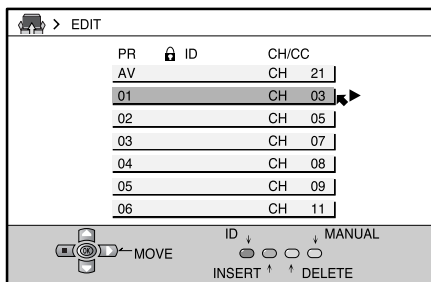

- 3 Choose the channel which you want to register.

- 4 Press the blue button to activate the MANUAL function.

The sound system of the channel appears at the right of the CH/CC number.

- 5 Press the ► button to choose an appropriate sound system.

For details, see "SOUND SYSTEM" on page 11.

- 6 Press the green or red button to search for the TV channel.

Searching stops when a channel is found and displayed.

- 7 Repeat step 5 until your desired TV channel appears.

If the reception is poor	Press the blue or yellow button to fine tune the TV channel.
--------------------------	--------------------------------------------------------------

If noisy sound is heard	Press the ► button to choose an appropriate sound system.
-------------------------	-----------------------------------------------------------

- 8 Press the MENU/OK button to exit the menu.

To edit the channel list (PR LIST) (MOVE and DELETE in the EDIT menu)

You can edit the TV channel list as you like.

Note: After this operation, other channel's PR numbers will be changed.

- 1 Display the INSTALL menu.

* [MENU] → [INSTALL]

- 2 Choose EDIT/ MANUAL, then press the MENU/OK button. EDIT menu appears.

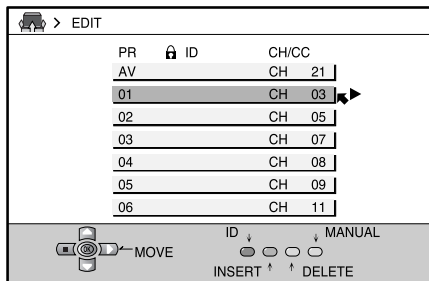

- 3 Choose the channel which you want to change PR number, or delete.

- 4 Do the following action:

To change the PR number (MOVE)	Press the ► button. Then move it to the PR number you want to use it for the channel. Finally press the ◀ button.
--------------------------------	-------------------------------------------------------------------------------------------------------------------

To delete the channel (DELETE)	Press the yellow button.
--------------------------------	--------------------------

- 5 Press the MENU/OK button to exit the menu.

* About the basic operations of the menu, please see the "How to operate menus and menu locations" on page 4.

TV channel presetting (continued)

To add in the new channel (INSERT in the EDIT menu)

You can add in the new channel in the TV channel list as you like.

You need to find the “CH/CC” number for the TV channel. Find the “CH/CC” number corresponding to the channel number of the TV channel from the attached sheet “CH/CC number list” on this page.

1 Display the INSTALL menu.

* **MENU** → **INSTALL**

2 Choose EDIT/ MANUAL, then press the MENU/OK button. EDIT menu appears.

3 Choose the PR number for which you will register a new TV channel. When you add a new TV channel of NTSC-M system, press the SOUND SYSTEM button to change the sound system to M. Then proceed to the next step.

4 Press the green button, then press ▲/▼ buttons to choose “CC” or “CH”.

5 Press the number button to enter the remaining CH/CC number.

The TV starts to search the TV channel, and the picture of the TV channel appears. If the TV finds no TV channel, a noisy picture appears.

When a TV channel has already been registered in PR99, using the INSERT function deletes that TV channel.

* About the basic operations of the menu, please see the “How to operate menus and menu locations” on page 4.

CH/CC number

When you want to use the INSERT function by the previous operation, find the CH/CC number corresponding to the channel number of the TV channel from this table.

Channel No.	Country
US	United States, Philippines, etc..
CCIR	Middle East, Southeast Asia, etc..
OIRT	Eastern Europe, Russia, Vietnam, etc..
AUSTRALIA	Australia, etc..

Channel

CH	US	CCIR	OIRT	AUSTRALIA	CH	US	CCIR	OIRT	AUSTRALIA
CH 02	US-2	E2	R1	AU-0	CH 36	US-36, W+ 51	E36		
CH 03	US-3	E3		AU-1	CH 37	US-37, W+ 52	E37		
CH 04	US-4	E4	R2	AU-2	CH 38	US-38, W+ 53	E38		
CH 05	US-5	E5	R6	AU-6	CH 39	US-39, W+ 54	E39		
CH 06	US-6	E6	R7	AU-7	CH 40	US-40, W+ 55	E40		
CH 07	US-7	E7	R8	AU-8	CH 41	US-41, W+ 56	E41		
CH 08	US-8	E8	R9	AU-9	CH 42	US-42, W+ 57	E42		
CH 09	US-9	E9			CH 43	US-43, W+ 58	E43		
CH 10	US-10	E10	R10	AU-10	CH 44	US-44, W+ 59	E44		
CH 11	US-11	E11	R11	AU-11	CH 45	US-45, W+ 60	E45		
CH 12	US-12	E12	R12		CH 46	US-46, W+ 61	E46		
CH 13	US-13				CH 47	US-47, W+ 62	E47		
CH 14	US-14, W+ 29				CH 48	US-48, W+ 63	E48		
CH 15	US-15, W+ 30				CH 49	US-49, W+ 64	E49		
CH 16	US-16, W+ 31				CH 50	US-50, W+ 65	E50		
CH 17	US-17, W+ 32				CH 51	US-51, W+ 66	E51		
CH 18	US-18, W+ 33				CH 52	US-52, W+ 67	E52		
CH 19	US-19, W+ 34				CH 53	US-53, W+ 68	E53		
CH 20	US-20, W+ 35				CH 54	US-54, W+ 69	E54		
CH 21	US-21, W+ 36	E21			CH 55	US-55, W+ 70	E55		
CH 22	US-22, W+ 37	E22			CH 56	US-56, W+ 71	E56		
CH 23	US-23, W+ 38	E23			CH 57	US-57, W+ 72	E57		
CH 24	US-24, W+ 39	E24			CH 58	US-58, W+ 73	E58		
CH 25	US-25, W+ 40	E25			CH 59	US-59, W+ 74	E59		
CH 26	US-26, W+ 41	E26			CH 60	US-60, W+ 75	E60		
CH 27	US-27, W+ 42	E27			CH 61	US-61, W+ 76	E61		
CH 28	US-28, W+ 43	E28			CH 62	US-62, W+ 77	E62		
CH 29	US-29, W+ 44	E29			CH 63	US-63, W+ 78	E63		
CH 30	US-30, W+ 45	E30			CH 64	US-64, W+ 79	E64		
CH 31	US-31, W+ 46	E31			CH 65	US-65, W+ 80	E65		
CH 32	US-32, W+ 47	E32			CH 66	US-66, W+ 81	E66		
CH 33	US-33, W+ 48	E33			CH 67	US-67, W+ 82	E67		
CH 34	US-34, W+ 49	E34			CH 68	US-68, W+ 83	E68		
CH 35	US-35, W+ 50	E35			CH 69	US-69, W+ 84	E69		

CC	US	CCIR	OIRT	AUSTRALIA	CC	US	CCIR	OIRT	AUSTRALIA
CC 01	S-1			AU-5	CC 38	W+ 2	S-38		
CC 02	S-2				CC 39	W+ 3	S-39		
CC 03	S-3				CC 40	W+ 4	S-40		
CC 04	S-4				CC 41	W+ 5	S-41		
CC 05	S-5				CC 42	W+ 6			
CC 06	S-6			AU-5A	CC 43	W+ 7			
CC 07	S-7				CC 44	W+ 8			
CC 08	S-8				CC 45	W+ 9			
CC 09	S-9				CC 46	W+ 10			
CC 10	S-10				CC 47	W+ 11			
CC 11	S-11				CC 48	W+ 12			
CC 12	S-12				CC 49	W+ 13			
CC 13	S-13				CC 50	W+ 14			
CC 14	A S-14				CC 51	W+ 15			
CC 15	B S-15				CC 52	W+ 16			
CC 16	C S-16				CC 53	W+ 17			
CC 17	D S-17				CC 54	W+ 18			
CC 18	E S-18				CC 55	W+ 19			
CC 19	F S-19				CC 56	W+ 20			
CC 20	G S-20				CC 57	W+ 21			
CC 21	H S-21				CC 58	W+ 22			
CC 22	I S-22				CC 59	W+ 23			
CC 23	J S-23				CC 60	W+ 24			
CC 24	K S-24				CC 61	W+ 25			
CC 25	L S-25				CC 62	W+ 26			
CC 26	M S-26				CC 63	W+ 27			
CC 27	N S-27				CC 64	W+ 28			
CC 28	O S-28				CC 75		X		
CC 29	P S-29				CC 76		Y	R3	
CC 30	Q S-30				CC 77		Z	R4	AU-3
CC 31	R S-31				C-78		Z+ 1	R5	
CC 32	S S-32				CC 79		Z+ 2		AU-4
CC 33	T S-33				CC 95	A-5			
CC 34	U S-34				CC 96	A-4			
CC 35	V S-35				CC 97	A-3			
CC 36	W S-36				CC 98	A-2			
CC 37	W+ 1 S-37				CC 99	A-1			

Additional preparation

Connecting the external devices

Connect the devices to the TV, paying attention to the following connection diagram.

Before connecting anything:

- Read the manuals provided with the devices. Depending on the devices, the connection method may differ from the figure. In addition, the device settings may be changed depending on the connection method to secure proper operation.
- Turn off all the devices including the TV.
- The "Specifications" on page 22 contains the details of the VIDEO terminals. If you are connecting a device not listed in the following connection diagram, see the "Specifications" to choose the best VIDEO terminal.
- Note that connecting cables are not supplied.

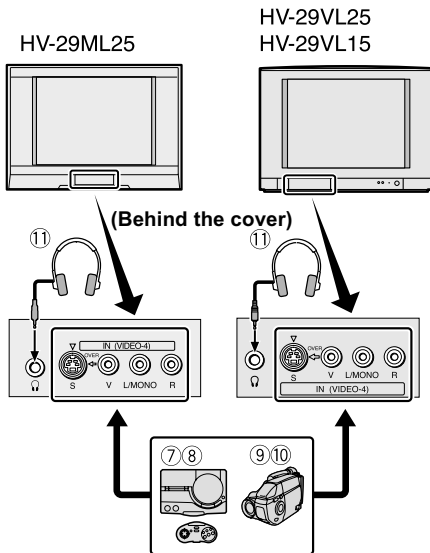

- ① VCR (composite signal)
- ② VCR (S-VIDEO signal; Y/C)
- ③ VCR for recording (composite signal)
- ④ DVD player (composite signal)
- ⑤ DVD player (S-VIDEO signal; Y/C)
- ⑥ DVD player (component video signals; Y, PB/CB . PR/CR)
- ⑦ TV game (composite signal)
- ⑧ TV game (S-VIDEO signal; Y/C)
- ⑨ Camcorder (composite signal)
- ⑩ Camcorder (S-VIDEO signal; Y/C)
- ⑪ Headphones

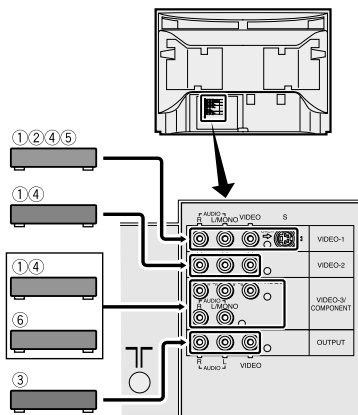

Troubleshooting

If a problem arises while you are using the TV, please read this “Troubleshooting” well before you request having the TV repaired. You may be able to fix it easily by yourself. For example, if the AC plug is disconnected from the AC outlet, or the TV aerial has problems, you may think there is a problem with the TV itself.

Important:

- This Troubleshooting guide only covers problems whose causes are not easy to determine. If a question arises when you are operating a function, read the page(s) corresponding to the operation of the function well, not this Troubleshooting guide.
- After you have followed the Troubleshooting description or the operating description of the functions concerned without any success, remove the AC plug from the AC outlet and request a repair of your TV. Do not attempt to repair the TV by yourself or remove the rear cover of the TV.

IF YOU CANNOT TURN ON THE TV

- Is the AC plug connected to the AC outlet?
- Is the POWER lamp lit? If not, press the Main power button.

NO PICTURE/NO SOUND

- Have you chosen a TV channel whose reception is extremely bad? In this case, the BLUE BACK function will be activated, the entire screen becomes blue, and the sound is muted. In spite of this, if you want to view the TV channel, follow the description “BLUE BACK” on page 9 to try to change the BLUE BACK function setting to OFF.
- Are your SOUND SYSTEM settings for the TV channels correct? Follow the description “SOUND SYSTEM button” on page 11 to try to solve the trouble.

AUTO SIGNAL DETECT IN DVD MENU DOES NOT WORK

- Please check that the AUTO DVD DETECT function is on or off.
- Press button (VCR or DVD Player) to turn the machine off and turn it on again ; do not turn the machine off and on suddenly.
- Inspect the video cable connection on VIDEO-3 that they are connected properly.

WHEN TV IS NOT VIDEO-3, AUTO SIGNAL DETECT WORK WHILE VCR OR DVD PLAYER WAS ON.

- Inspect the video cable connection on VIDEO-3 that they are connected properly.
- In a certain VCR or DVD Player, the function might operate by the discontinuity of the signal.

AFTER TV WAS ON, AUTO DVD DETECT WORK

- Video signal from VCR or DVD Player cause the function run properly to indicate that there are video signal on VIDEO-3 channel.

IF YOU CANNOT TURN ON THE TV

- If noise totally obscures the picture (snow), the aerial or aerial cable may have trouble. Check the following to try to solve the trouble: Has the TV and aerial been connected properly? Has the aerial cable been damaged? Is the aerial pointed to the right direction? Is the aerial itself faulty?
- If the TV or aerial receives interference from the other devices, stripes or noise may appear in the picture. Move such device as an amplifier, personal computer, or a hair drier that can cause interference away from your TV, or try changing its location. If the aerial suffers interference from a radio tower or high-voltage wire, please contact your local dealer.
- If the TV receives interferences from signal reflecting from mountains or building, double-pictures (ghosting) will occur. Try to change the aerial's direction or replace the antenna with the one with better directionality.
- Are your COLOUR SYSTEM settings for the TV channels correct? Follow the description “COLOUR SYSTEM button” on page 8 to try to solve the trouble.
- Has COLOUR or BRIGHT been controlled properly? Follow the description “PICTURE SETTING” on page 8 to try to adjust them properly.
- Videotaping teletext is not recommended because it may not record correctly.
- When a white and bright still image (such as a white dress) is displayed on the screen, the white part may look as if it were coloured. It is a phenomenon unavoidable due to the nature of the picture tube itself, and not due to a TV failure. When the picture disappears from the screen, the unnatural colours will also disappear.
- When viewing images from commercially available video software products, or videos from videotapes which have been recorded improperly, the top of the image may be distorted. This is due to the condition of the video signal, and not because of malfunction.

Troubleshooting (continued)

POOR SOUND

- Have you adjusted BASS or TREBLE properly? If not, follow the description “Adjusting the sound” on page 11 to try to adjust them properly.
- When the TV channel reception is poor, it can be hard to hear the stereo or bilingual sound. In this case, follow the description “STEREO / I•II” on page 11 to hear the sound more easily by changing it to a mono sound.

OPERATION DISABLED

- Have the batteries of the remote control become exhausted? Follow the description “Putting the batteries into the remote control” on page 6 and replace them with new batteries to try solve the problem.
- Have you attempted to use the remote control at the sides or rear of the TV or at a location more than seven meters apart from the TV location? Operate the remote control in the front of your TV or a location less than seven meters from your TV to try to solve the problem.
- When you are viewing a teletext programme, you cannot operate the menus. Press the TV/VIDEO button to return the teletext programme to the ordinary TV programme to try operating the menus.
- Is the CHILD LOCK function set to ON? If the CHILD LOCK function is set to ON, you cannot operate the TV with the front control buttons of the TV. Follow the description “CHILD LOCK” on page 15 to try to set the CHILD LOCK function to OFF.
- If the TV operation becomes disabled suddenly, press the Main power button on the TV and turn off the main power. Try to press the Main power button again to turn on the main power. If the TV returns to a normal state, it is not a failure.

OTHER CONCERNS

- When the AUTO SHUTOFF function operates, the TV is automatically turned off. If the TV is turned off suddenly, try to press the POWER button to turn on the TV once again. At this time, if the TV resumes a normal state, there is no problem.
- If you bring a magnetized device such as a speaker near to your TV, a picture may be warped or unnatural colours appear at the corners of the screen. In this case, keep the device apart from your TV. If the speaker causes such phenomena, use the magnetic-shielded speaker instead.
- A picture may be tilted due to the influence of the earth’s magnetism. In this case, use the “PICTURE TILT” on page 9 to complete the tilt.
- It takes a short period of time from the time an operation such as changing channels is performed until an image is displayed. This is not a malfunction. This is the time required for the image to stabilize before it can be displayed.
- The TV may emit a crackling sound due to a sudden change in temperature. It does not matter if a picture or sound does not show any abnormality. If you hear crackling sounds frequently while you are viewing the TV, other causes may be assumed. For precautionary purposes, request your service technician to inspect it.
- Touching the screen may cause you feel a slight electric shock due to its static electricity. It is an unavoidable phenomenon due to the construction of the picture tube. It is not a problem with the TV. You can rest assured that this static discharge does not have harmful influence over the human body.

Specifications

Broadcasting systems	B, G, I, D, K, K1, M
Colour systems	PAL, SECAM, NTSC3.58/4.43MHz
Channels and frequencies	VHF low channel (VL) = 43.25 MHz ~ 140.25 MHz VHF high channel (VH) = 147.25 MHz ~ 423.25 MHz UHF channel (U) = 431.25 MHz ~ 863.25 MHz • Receives cable channels in mid band (X to Z+2, S1 to S10), super band (S11 to S20) and hyper band (S21 to S41).
Sound-multiplex systems	A2 (B/G), NICAM (B/G, I, D/K) system
Teletext systems	FLOF(Fastext), WST(World Standard Text) [Except HV-29VL15 only]
Languages displayed by	Please see the table in the description "TELETEXT LANGUAGE" on page 10. [Except HV-29VL15 only]
Power requirements	AC 110 to 240V, 50/60Hz
Audio output	Rated Power output: 10W + 10W
VIDEO-1 terminal	RCA connector x 3, S-VIDEO connector x 1 • Video input, S-VIDEO (Y/C) input and Audio L/R inputs are available.
VIDEO-2 terminal	RCA connector x 3 • Video input and Audio L/R inputs are available.
VIDEO-3/COMPONENT	RCA connector x 5 terminal • Video input/Component video (Y. PB/CB . PR/CR) input and Audio L/R inputs are available.
VIDEO-4 terminal	RCA connector x 3, S-VIDEO connector x 1 • Video input, S-VIDEO (Y/C) input and Audio L/R inputs are available.
OUTPUT terminal	RCA connector x 3 • Video output and Audio L/R outputs are available.
Headphone jack	Stereo mini-jack (3.5 mm in diameter)
Accessories	Remote control unit x 1 RM-C1390 [All models] AA/R6 dry cell battery x 2
Speakers	(13cm x 6.5cm) x 2

Design and specifications subject to change without notice.

Pictures displayed on the screen using this TV's ZOOM functions should not be shown for any commercial or demonstration purpose in public places (cafes, hotels, etc.) without the consent of the owners of copyright of the original picture sources, as this constitutes an infringement of copyright.



JVC